

MID-HUDSON CHAPTER of the DUTCH BARN PRESERVATION SOCIETY

May, 1999 Newsletter

This is the third newsletter of the Mid-Hudson Chapter, an unofficial and unstructured group. We now have 21 paying members and \$206 in the bank. Last month 125 newsletters were printed and 75 sent by mail at a cost of \$95 for postage and printing. A few more of this May issue will be printed and mailed but we must eventually cut back on distribution to unofficial non-paying members. So, mail your official \$10 contribution to be assured of receiving future issues of this unstructured newsletter.

Reports on two Dutch barns of possible pre-Revolution date are included in this newsletter. The first, a single-aisle Dutch barn in Warwarsing, Ulster County was discovered by Susan Sahler of Rochester, and the second, the six-bay Van Allen Dutch barn in Columbia county Bob and Amelia Anderson arranged for a group to visit and document. The Van Allen barn was on the first Dutch Barn Preservation Society tour that I was ever on about 9 years ago. I recall Shirley Dunn saying someone should return and document the corn crib. We did examine the 17 x 21-foot building last month and got a picture of it but we spent most of our time in the barn so we still need to return.

Saturday, May 22, 1999 about 25 people attended a trustees meeting of the DBPS at the 1747 Parsonage in Germantown (Ger-4) home of the Germantown Historical Society and the Mid-Hudson Chapter of Palatines to America. The original banked stone building had one room with a side entrance-hall and a kitchen in the cellar. A tour of the building was made and Michael Carr then gave a slide talk about issues and techniques of the contemporary timber frame carpenter. Many of the slides were of frames he has worked on. Michael is active in the Timber Framers Guild of North America (TFG) and a member of the Guild's Traditional Timberframer's Research and Advisory Group (TTRAG). After coffee and refreshments some of the group did a tour of Columbia County barns. The report is included in this newsletter.

A short article by Greg Huber of Wyckoff, New Jersey, in Timber Framing Journal of the Timber Framers Guild, June 1999, tells of the destruction by fire of an 18th century Dutch Barn in Monmouth County, New Jersey, that was probably one of the largest examples, having a 32-foot nave and 22- to 24-inch deep anchorbeams. He regrets not having documented it better.

The Saturday meetings at the Oliver barn in Marbletown have been successful with interesting people dropping by and work on the windows and the encroaching vegetation progressing. We have meet the Pollock family who own the hay barn and the elegant 1865 stone Italianate house of the Bevier family next door.

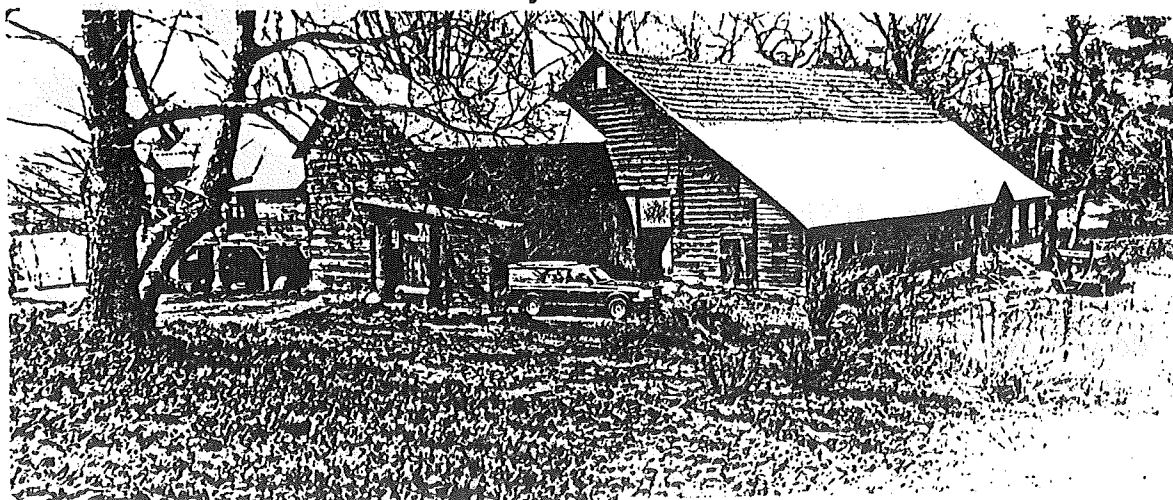

Oliver 7-bay Dutch barn complex (Mar-6) Marbletown, Ulster County, NY
May 1999, Neg. # 197

2.

It seems that there were once three cast-iron historic markers at this place on Route 209, what was once the main road from the Esopus to the Delaware Valley. The sign across the road from the Oliver barn at the Widow Davis Tavern is the only one still standing. It reads, "For many years before and after the Revolution the public business of the Town of Marbletown was transacted here." This sign was erected in 1926.

The 1929 historic marker at the Oliver house is thought to have been destroyed by a snow plow and is missing but the third marker was evidently removed by the previous owner of the Bevier house and lies at the entrance to the hay barn which served him as a sculpture studio. This marker says that George Washington stood "on this spot" in 1777. Naturally this made the new owners of the Bevier barn think that it was an 18th century building once visited by Washington. "this spot" should be understood as "this area of Marbletown" at the North Marbletown Church and Cemetery. The barn was constructed about 1865, same as the house.

Two Mid-Hudson Valley Dutch Barns of Possible Pre-Revolutionary Construction

The ___/Horowitz (Waw-3) 3-bay scribe-rule single-aisle Dutch barn with a 5-bay square-rule addition is located on Lundy Road, Hamlet of Wawarsing. The property is for sale with 2 or 3 acres and two houses. It was visited May 5 & 17.

The 3-bay single-aisle Dutch barn has a pine frame, 11 pair of rafters with bird-mouths at the plate, three pins on the anchorbeam joint at the column and no tie beams on any bents. The end bents have no anchorbeam braces. All rafter pairs have collar ties and all braces are hewn. It had wooden hinged wagon doors on bent 4. Bent 4 now has an unusual pulley system cut through at the top of each column probably used with the late 19th century hay track.

This single aisle Dutch barn is similar to the DeWitt/Gazlay barn about 5-miles away on Route 209 in Rochester (#59, page 35 Rochester Barn Report) given an estimated date c1815-1820. Both barns have internal "swing beams" that are larger at the center than at the columns.

The single aisle is a rare type of Dutch barn. Like the house frame it is distinguished by the use of H-bents and collar ties on the rafters. The single aisle barn has end entrances. (Waw-3) has ties on all eleven pairs of rafters. Some of its features such as its long hewn purlin braces that join the columns below the anchorbeam and the barn's high pitched roof seem to date it pre-Revolutionary. Circa 1760-1770.

The later 5-bay Dutch frame addition has horizontal girts for vertical siding, indicating Anglo-American influence. The rafters of this square-rule frame butt at the peak, the purlin braces are not pinned and the up-and-down saw marks on braces and flooring indicate an 1840-1860 date for it. The lower sections of the four pairs of internal columns were replaced with metal posts when the barn was converted to a modern dairy, but the pair of columns joined to the 3-bay Dutch barn indicate the 5-bay frame was a single aisle barn with lowered anchorbeams in the end bay or bays. Its 6 1/2-foot wide side-aisle was added to make the side walls continuous with the 3-bay barn.

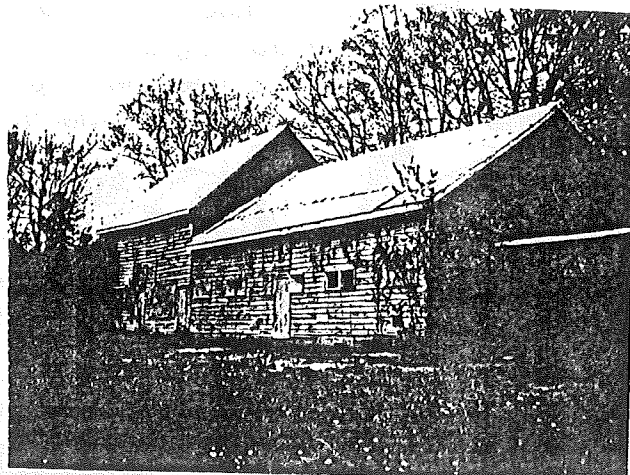

**___/Horowitz 3-bay single-aisle Dutch barn (Waw-3)
Wawarsing, Ulster County, NY; circa 1760-70
May 1999, Neg. # 199**

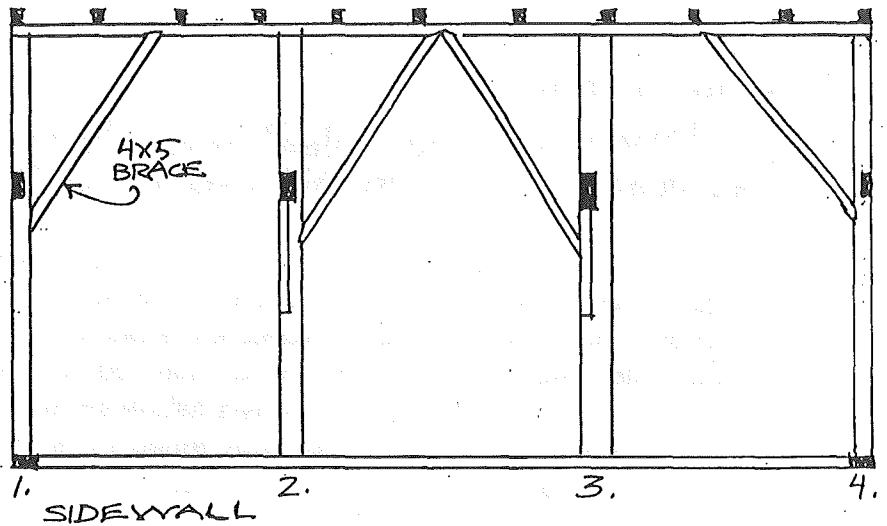
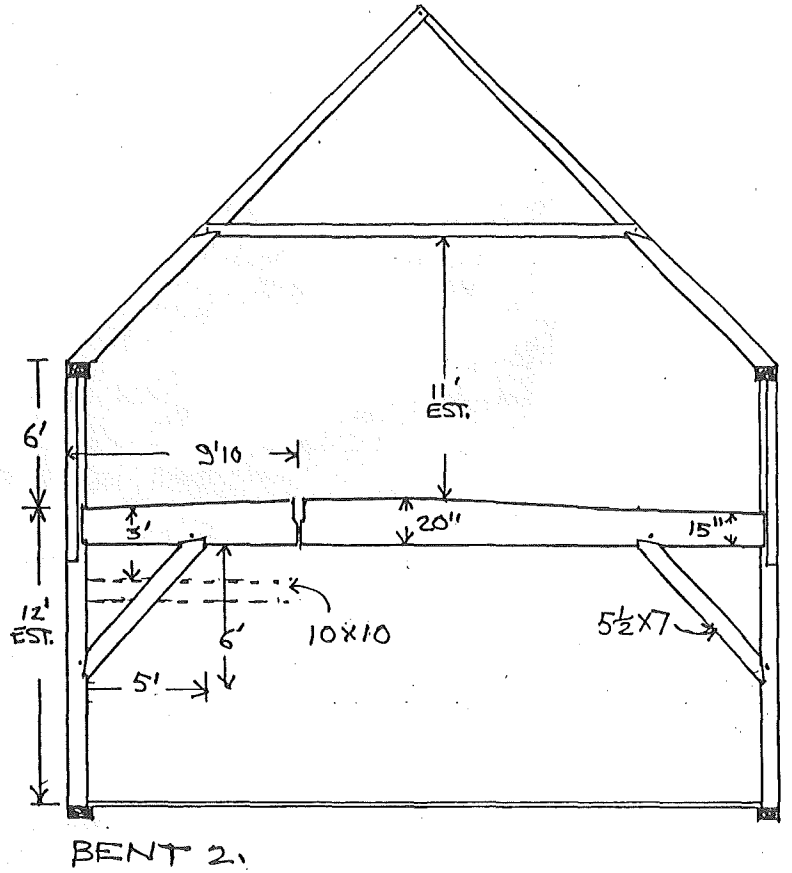
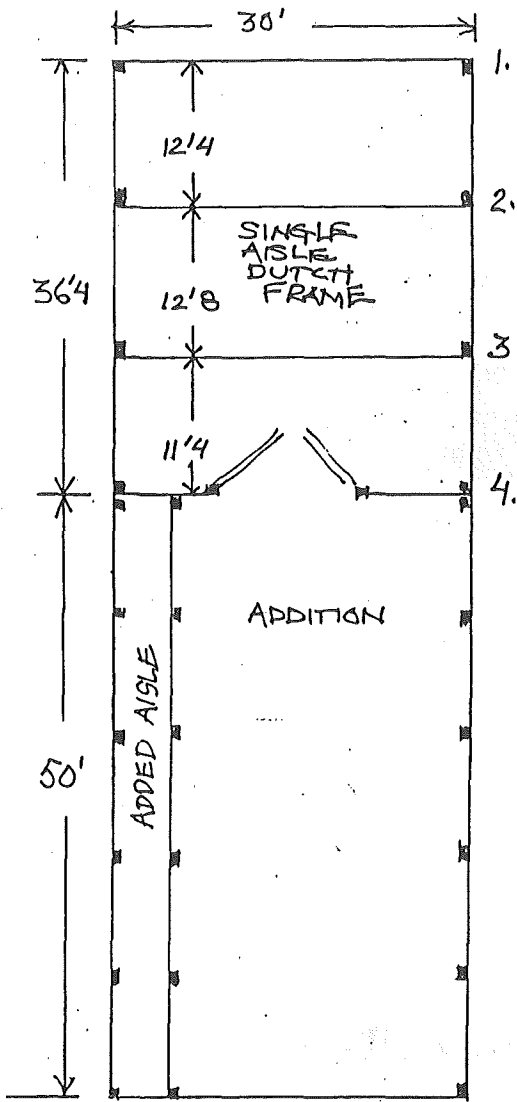

(Waw-3) 3-bay single-aisle Dutch barn dimensions in inches

Anchorbeams	Columns
1. 8 x10	9x10
2. 15-20x10	9x16
3. 12 x10	9x12
4. 12-14x9	9x11

Floor Plan, Bent 2. and Sidewall
/Horowitz 3-bay Single-aisle Dutch barn (Waw-3)
Wawarsing, Ulster County, NY; circa 1760-1770

A more careful and complete study of this barn should be made. The 30-foot anchorbeam in bent 2. measures 20-inches in depth at its center point and 15-inches where it joins the columns. This "swing-beam" condition is relatively rare in Dutch barns.

4.

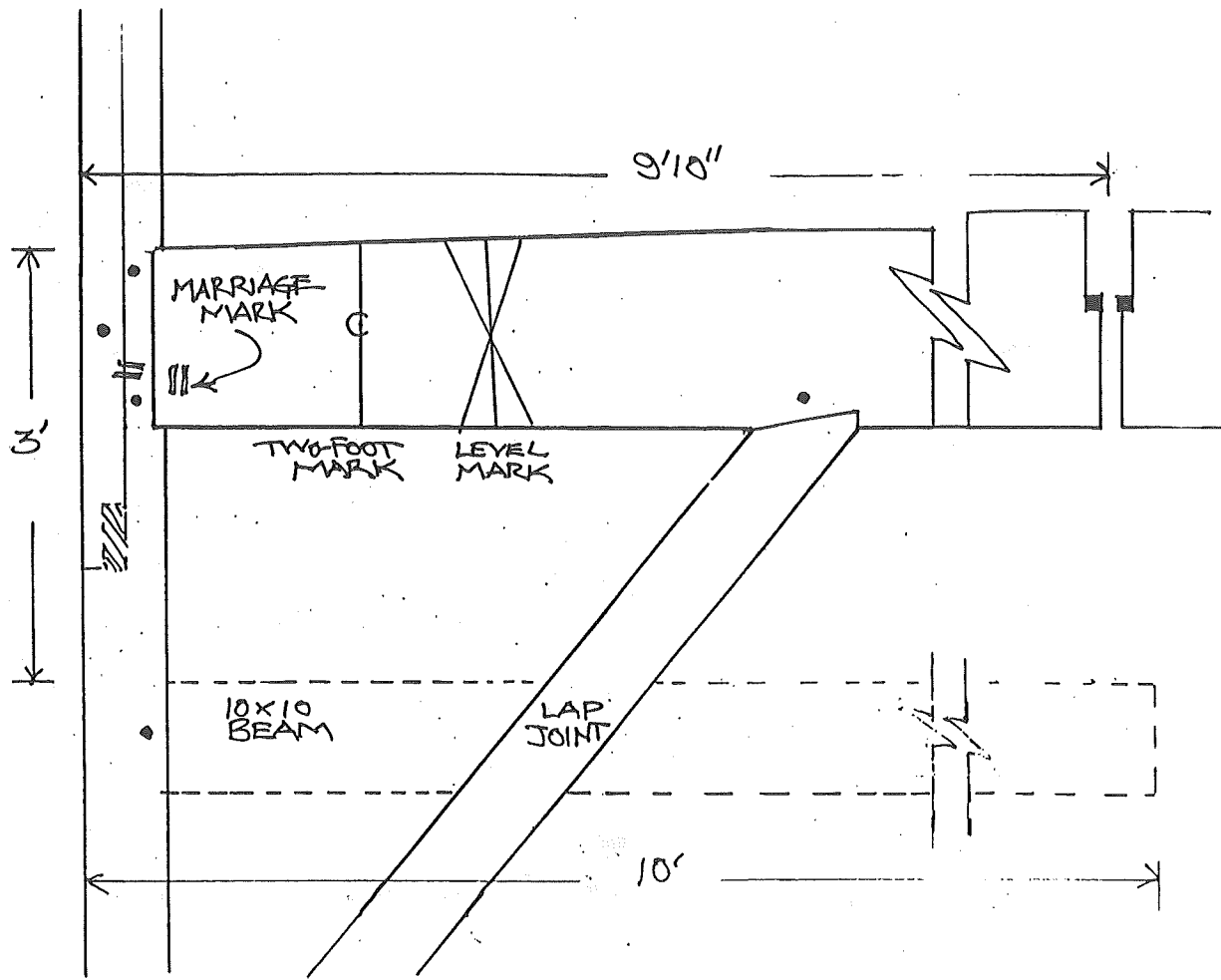

Detail of Bent 2.

/Horowitz 3-bay Single-aisle Dutch barn (Waw-3)

Wawarshing, Ulster County, NY; circa 1760-1770

The shoulder where the column and anchorbeam join is square rather than diminished as in the Van Allen Dutch barn (Liv-6). A full set of carpenters marks are found on this bent. The **marriage marks** on the columns and beams are roman numerals cut cross-grain with a chisel.

A **two-foot scribe mark** is scratched cross-grain on the face of the anchorbeam with an awl. This line is then marked with a half circle scratched with a divider. The two-foot mark, set in 24-inches from the back of the column, was a reference line for cutting the mortise and shoulder of the column to fit the beam. It is frequently found on scribe ruled frames.

The **level mark** is traditional in both English and Dutch scribe-rule carpentry. The center line, scratched across the grain marks a level spot on the lay-out face of the beam determined with a plumb-bob. This line is then marked with two long diagonal lines that cross at the center. A level line is found at the other side of the beam by sighting it with the first line and cutting away the wood with an adze which might be high. These level lines are then used to align the two anchorbeam tenons despite any twist in the beam.

The anchorbeam has a vertical hole 9-feet 10-inches from the back of the column. The lower half is 2-inch in diameter the upper half 4-inches in diameter with a one-inch thick 4-inch diameter outside-diameter iron washer insert. These seem to be associated with the two missing transverse beams set 3-feet below the anchorbeam in Bent 1. and 2. It may have been part of an early horse-power mechanism.

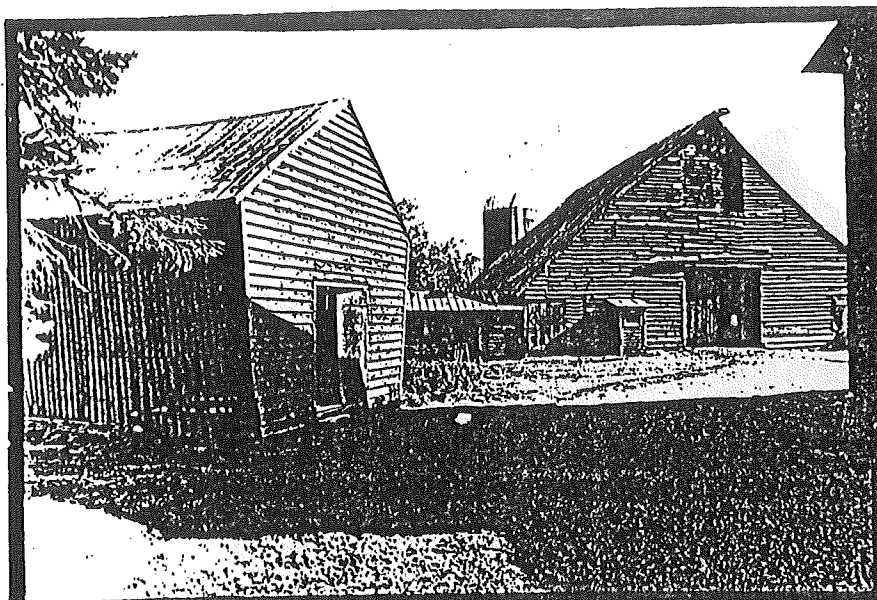

**Van Alstyne/Harris & Sullivan, 6-bay Dutch Barn and Corn Crib (Col-Liv-7)
Livingston , Columbia County, NY**

May, 1999 neg.#199

Saturday, May 15, 1999 with Roger Scheff, Catherine, Amelia and Bob Andersen visited the Johannes Van Alstyne/Harris & Sullivan homestead (Col-Liv-7) the township of Livingston , Columbia County, Timothy Sullivan & Patrick E. Harris, with story-and-a-half gambrel-roof brick house, six-bay Dutch barn (Fitchen #11) and outbuildings. We measured the barn and the corn crib.

The barn is situated more than 300 feet from the house. The house is oriented to the road while the barn is north-south and corn crib north-west. The house is estimated at 1765 and the barn seems consistent with that date. All braces are hewn, have diminished shoulders and there are no braces on the end bents. The marriage marks are in roman numerals with size indicating left and right but they lack the "V". Thus six is marked "IIIIII" instead of "VI"

There is a three-part wooden hinged wagon door at the south end of the barn. It is in bad condition and should be restored and protected with a pentice roof. The door is 9'6" wide. It is narrow. 11-feet is a more normal width. The wooden hinges are set into slots on the door posts and the pintals are inset into the post. This last feature is characteristic of some barns on the east side of the Hudson River.

The six bays of the barn are narrow and there is evidence in the columns, longitudinal struts and sills of the west side of specialized built-in mangers and perhaps a grain room. There seem to have been no transverse struts to the side wall posts on the east side as there are no mortises in the back sides of the internal columns. This was a feature of the Skinkle Dutch barn (Tac-2), now destroyed, in Taconic, Columbia County. There are mortises in the back sides of the longitudinal struts that suggest these served a similar function to connect the columns and side walls. There is evidence on both sides of a double longitudinal strut system in four of the west side bays and five on the east side. The upper strut mortises have a load bearing shoulder while the missing lower struts had none.

The corn crib has a hewn frame with sawn braces and some sawn studs but the oak side slats are joined to the girts with rose head nails and the strap hinges, on the two-part doors with removable center pole, have rolled eyes, indicating that this building may also be 18th century but perhaps later than the barn.

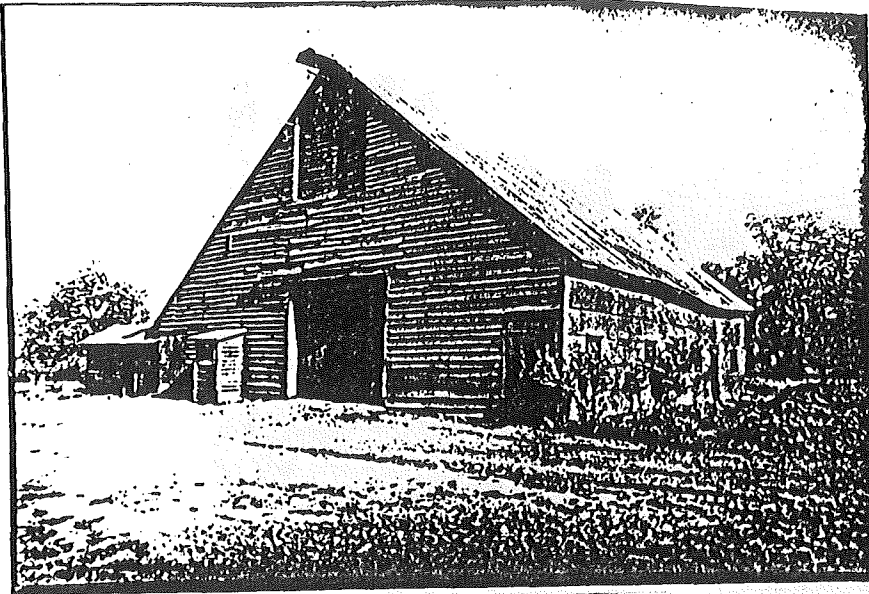

Van Alstyne/Harris & Sullivan, 6-bay Dutch Barn (Stu-2)
 circa 1765, Columbia County, NY May, 1999 neg.#199
 The doors and the extended hay-track at the peak of the roof
 are late nineteenth-century changes.

Detail, Bent 6.

6-Bay Dutch Barn, circa 1765

Johannes Van Alstyne/Harris & Sullivan (Col-Liv-7)

Livingston, Columbia County, NY

The extended anchorbeam tenon is shorter than the beam and has a wedge into the mortice above the tenon suggesting that there is a dovetail on the tenon to lock the beam in place. This is an uncommon design in the Hudson Valley. Many features such as the diminished shoulders and the use of three pins on the beam and brace suggest an 1765 date is close.

The centered mortice indicated with a dotted line on the column is set 14-inches below the longitudinal struts. It was found in four of the bays on the west side (see section A.). These seem to have been part of the original stake manger for which there are a series of holes and mortices cut into the sill bellow.

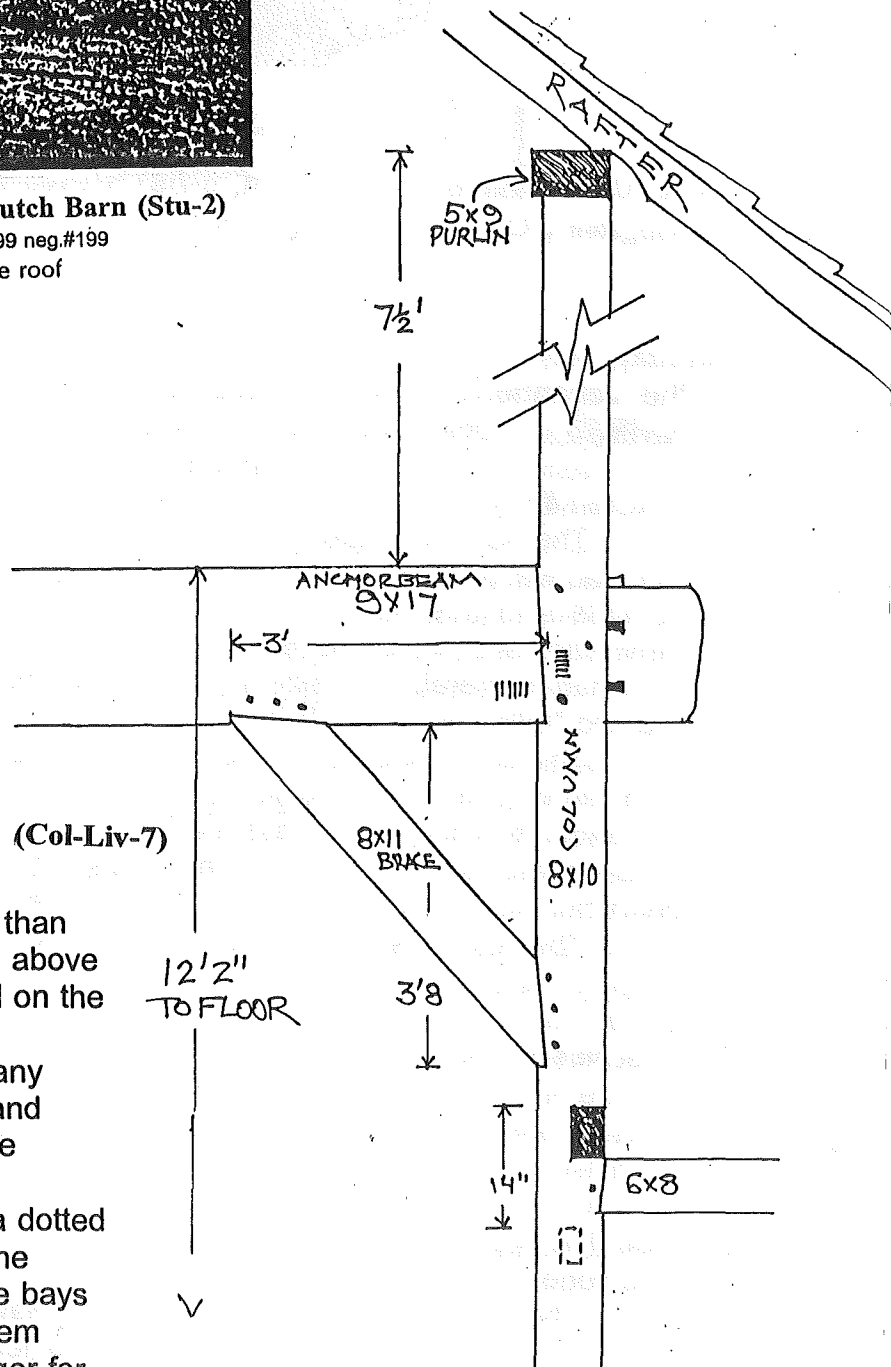

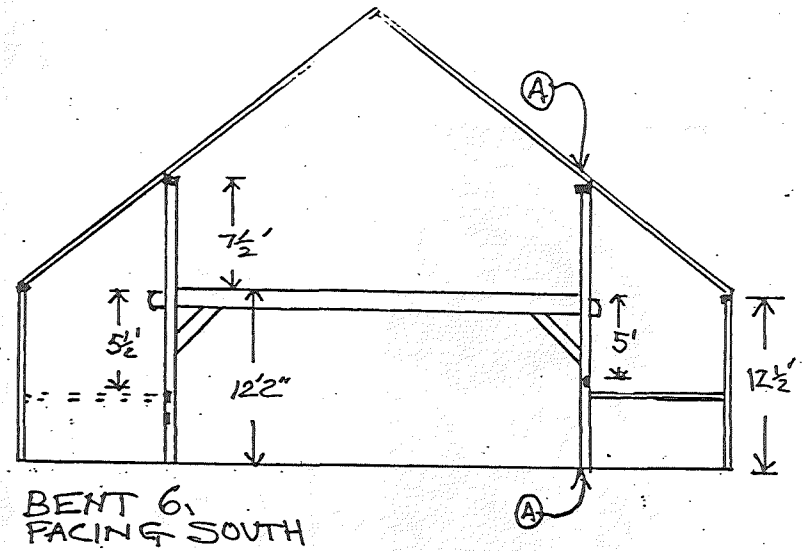
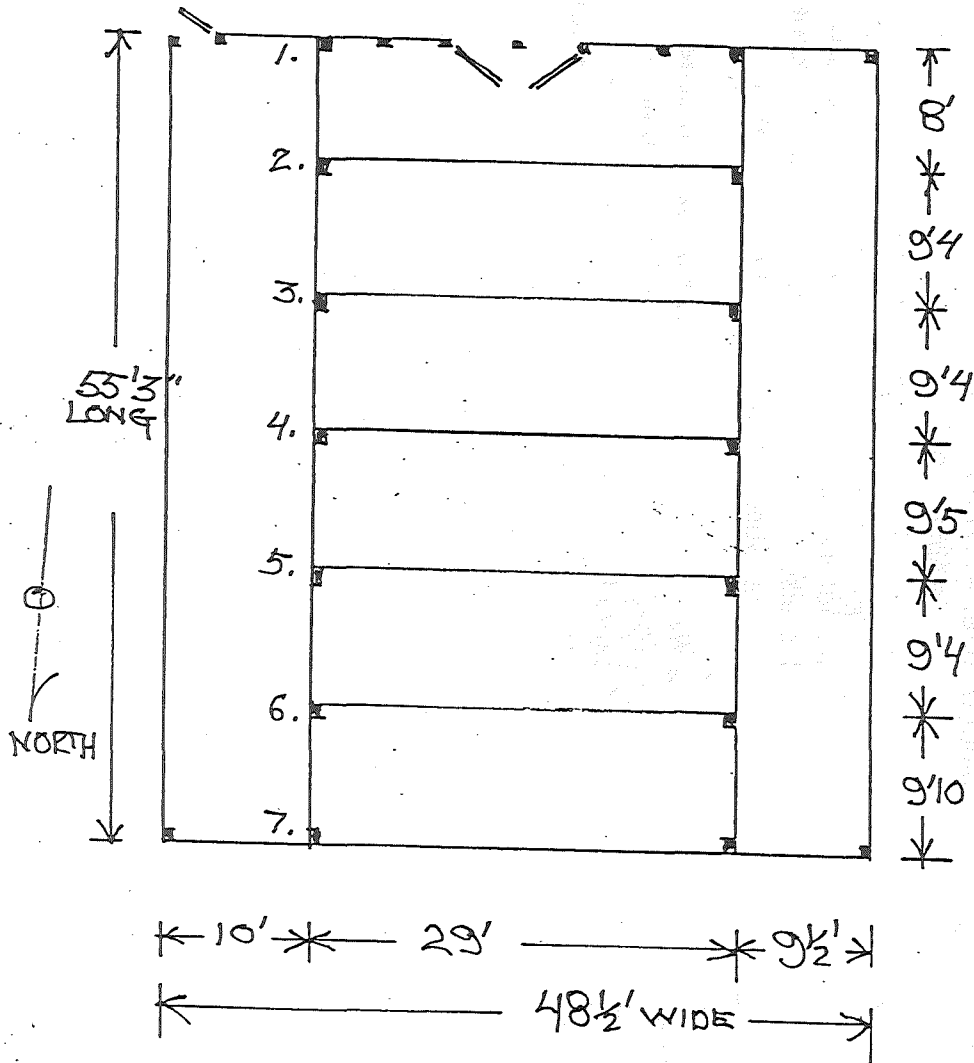

BENT 6,
FACING SOUTH

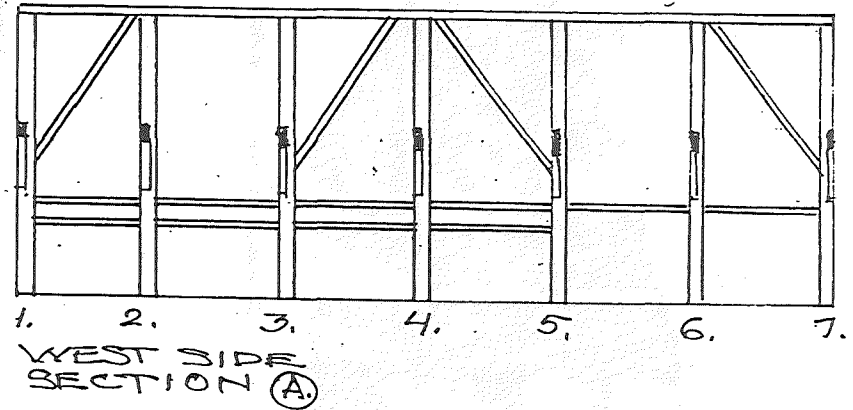

Anchorbeam 1.

- 2. 13 x 10
- 3. 15 x 10
- 4. 18 x 10
- 5. 20 x 10
- 6. 17 x 9
- 7.

Floor Plan, Bent 6. and Section

6-Bay Dutch Barn, circa 1765

Johannes Van Alstyne/Harris & Sullivan (Col-Liv-7)

Stuyvesant, Columbia County, NY

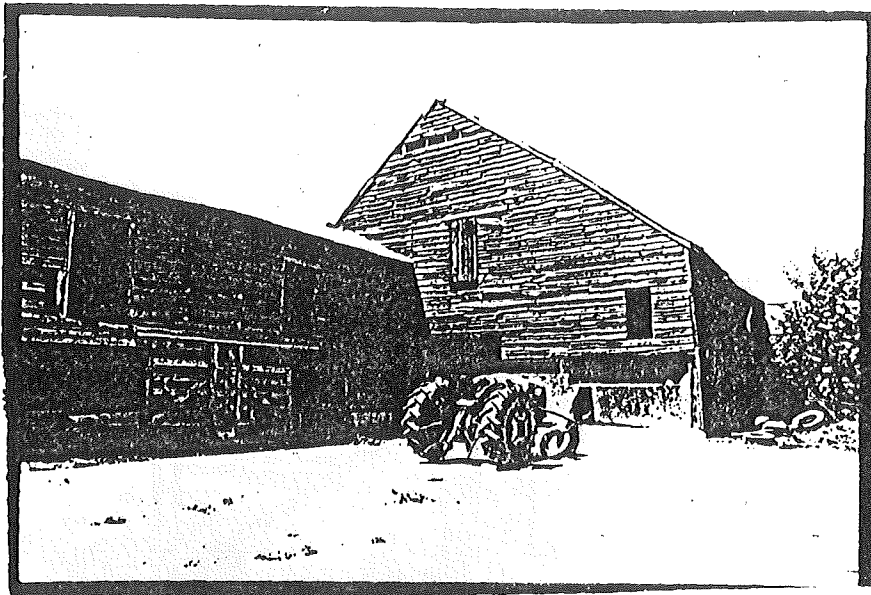

 /Stark 4-bay Dutch Barn (Ghe-3)
Ghent, Columbia County, NY; May 1999, neg #199

Saturday, May 22, 1999 about 25 people attended a trustees meeting of the DBPS at the 1747 Parsonage in Germantown (Ger-4) home of the Germantown Historical Society and the Mid-Hudson Chapter of Palatines to America. The original banked stone building had one room with a side entrance-hall and a kitchen in the cellar. A tour of the building was made and Michael Carr then gave a slide talk about issues and techniques of the contemporary timber frame carpenter. Many of the slides were of frames he has worked on. Michael is also active in the Timber Framers Guild of North America (TFG) and a member of the Guild's Traditional Timberframer's Research and Advisory Group (TTRAG).

Three Columbia County barns were toured. The **Lasher/Erickson/Meacher Dutch barn (Ger-9)**, that was documented in March and reported in the April newsletter, was revisited. The "ME" carved up-side-down on the fourth anchorbeam, some said it is "MF", could be the carpenter's initials. The race-knife marriage marks are distinct.

Additional observations included a lead screw on the drill bit, dating the frame to after 1790. There were no tie-beams on internal bents 2. and 4. The barn is in stable condition and undergoing repairs by the owner.

We next visited the /Stark Dutch barn (Ghe-3) on Route 9, north of Philmont and south of Ghent. The frame is primarily of pine. All mortise shoulders are diminished and all braces are hewn. The long 3" x 5" oak purlin-braces may have been riven.

The proportions of the barn are classic with a 22-foot naive and 10-foot side aisles making the 42-foot width of the barn slightly more than the 40-foot length.

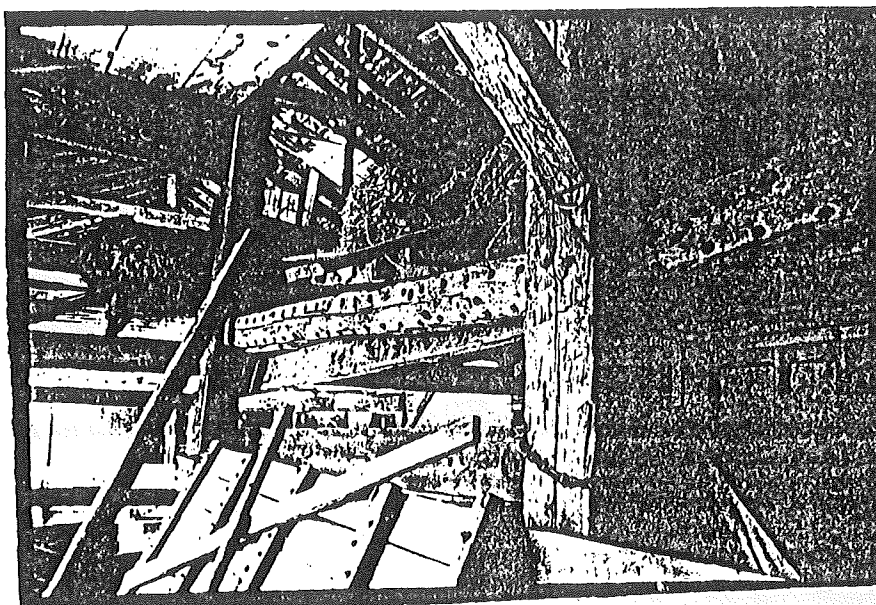

___/Stark 4-bay Dutch Barn (Ghe-3)
Ghent, Columbia County, NY; May 1999, neg #199

The carpenter's scribe marks are typical roman numerals. The lines formed with a double cut of a chisel. The width of the chisel denoting left and right. There are tie beams only on the external bents 1. and 5. One of the most unusual features of the barn are the double set of angled holes in the west longitudinal struts for a stake manger. There is a typical 1" groove on the columns below the struts, probably for a horse feed troth, but the design of the Dutch barn stake manger is not well understood and this example is unique.

This seems to be an 18th century barn. The original threshing floor has been set on top of the anchorbeams allowing an interesting view of the underside. The barn has been neglected and unused for years and one side of the roof now has large holes which are letting in rain. Unless tarps are placed on the roof and some use is found to save the building, it will soon be beyond saving.

Last we visited the ___/Root farm (Cha-1) off route 66 on Rider's Mill Road near the Rensselaer County line and looked at a number out buildings and barns including two early-nineteenth century English 3-bay side-entrance barns with partial basements. The earliest barns had scribe-rule frames, through tenons and were framed for clapboard, but there were no raising holes.

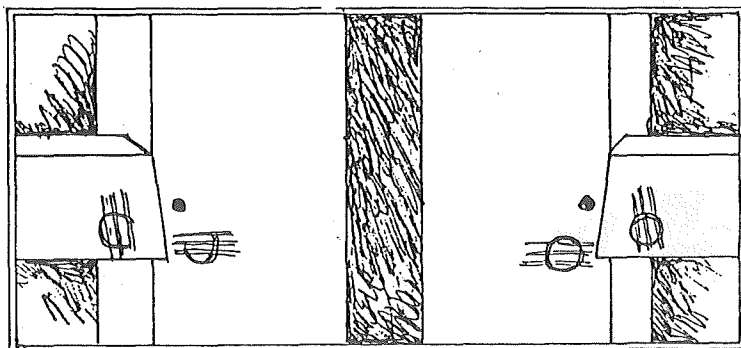

Marriage Marks

Lasher/Meacher Dutch Barn (Ger-9)

These marriage marks are cut with a race knife and race knife compass.

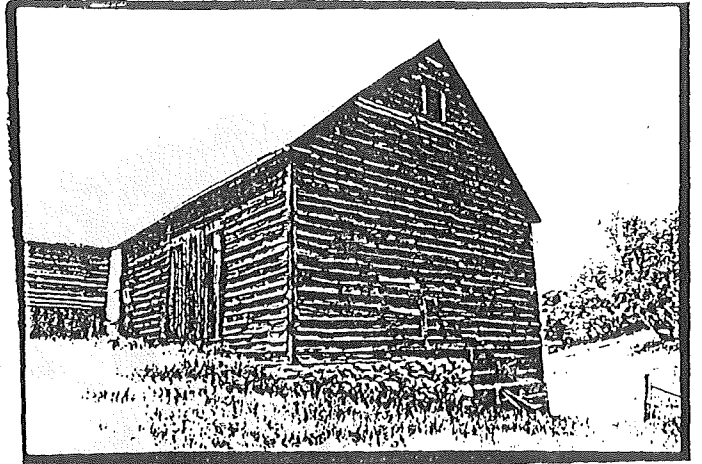
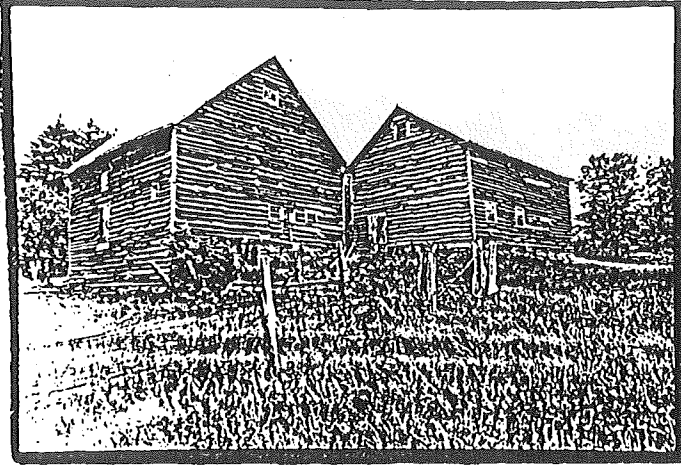

**A Pair of 3-bay Side-entrance Barns
Root Farm (Cha-1) Chatham, Columbia County, NY**

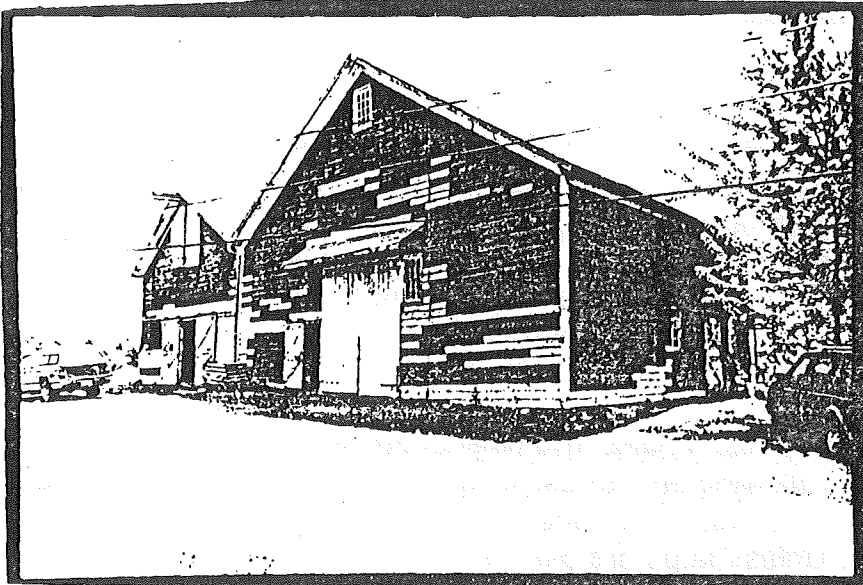

**Lasher/Meacher
4-bay Dutch Barn (Ger-9)
Germantown, Columbia Co., NY**

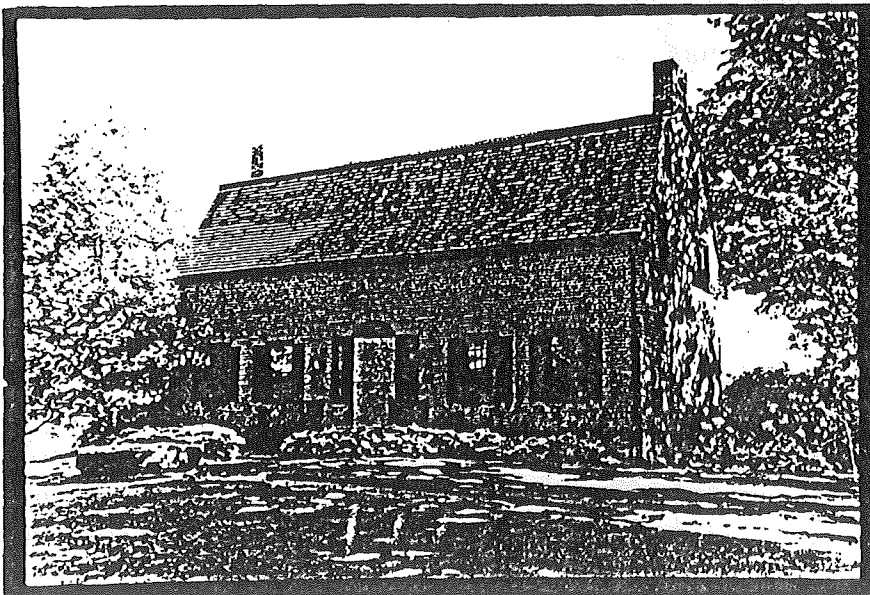

**1765 Van Alstyne/
2-story Brick House (Liv-6)
Livingston, Columbia Co., NY**

Tour of some local barns and houses
**Saturday, June 17,
1999, 10:00 AM**

The Brush House, Main and Church Street
Pine Plains, Dutchess County, NY

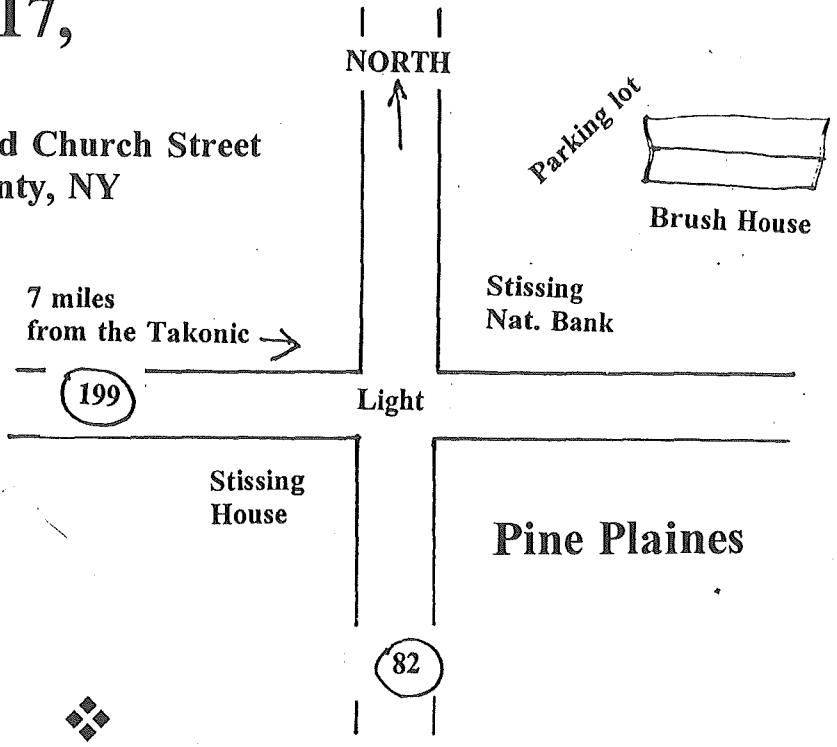

MEETINGS OF THE MID-HUDSON CHAPTER 10 to 5 PM

Saturday, June 26, 1999

Saturday, July 3, 1999

Oliver Dutch barn, 2911 Route 209

Marbletown, Ulster Co., NY

(across from the Widow Davis Tavern)



ANNUAL MEETING

of The Dutch Barn Preservation Society

Saturday, October 23, 1999

Old Stone Fort Museum Complex

Schoharie, New York



The Newsletter of the Mid-Hudson Chapter of the Dutch Barn Preservation Society
and notice of up-coming events will be made available with a \$10 membership.
Mail to Peter Sinclair, 83 Spillway Rd., West Hurley, NY 12491; (914) 338-0257

.....
I would like to join the Mid-Hudson Chapter of the Dutch Barn Society

NAME _____

ADDRESS _____

CITY _____ STATE _____ ZIP _____

.....